

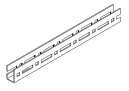









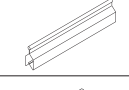

# ORCAL 3000 SYSTEEM

Halfverdekte en verdekte systemen.  
Voor Clip-In 3mm

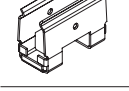
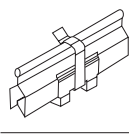
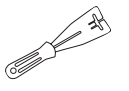

## Voor gebruik met 3 mm Clip-In producten

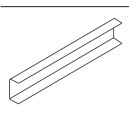
		Item Nr.	Omschrijving	Afmetingen (mm)	Hoeveelheid stuks	Gewicht/Pak kg	
	Methode 1 ①	BPM 300100	U-draagprofiel	3750	10	30,00	
	②	BPM 300121	Ophangbeugel voor 6mm draadeind		100	2,20	
	③	BPM 300119	U-draagprofiel langverbinder		100	4,70	
	④	BPM 300140	Universele wandbevestiging		100	3,90	
	⑤	BPM 300120	Borgclip		100	0,30	
		BPM 311149	Half klemprofiel		10	21,30	
	⑥	⑥	BPM 311022	Klemprofiel	4000	10	20,00
	⑦	⑦	BPM 300138	Klemprofiel langverbinder		100	0,70
	⑧	BPM 300105G	Klemprofiel voor U-profiel		100	0,60	
	⑨	BPM 300106	Veiligheidshaak		100	0,30	
	⑭	BPM311027	Clip-In Swing down clip	-	100	2,40	
	⑩	BPM 300157	Veiligheidsklem voor scharnierclip		100	0,60	
	⑪	⑪	BPM 311046	Demontage gereedschap	1		
		⑫	BPC 1502 G	Klemprofiel voor C-profiel	200	10,00	
		⑬	BPC 3000 G	C-profiel	4000	8	23,80



# ORCAL 3000 SYSTEEM

## Detailtekeningen (moduul 600 x 600 mm)

### Methode 1

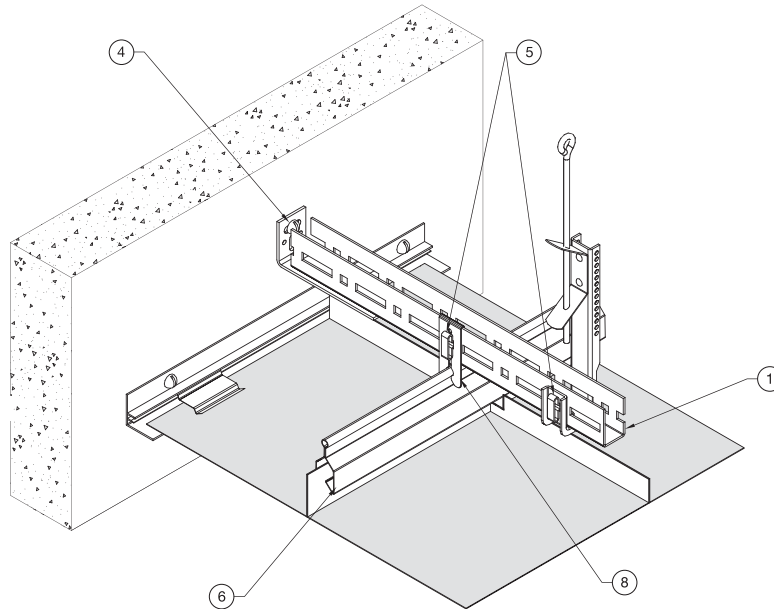

### Methode 2

600 x 600 mm moduul

Afmeting A 600 mm

Afmeting B 1500 mm\*

Afmeting C 1200 mm\*

*\*Aanbevolen systeem configuratie.  
De afstand tussen wandaansluiting  
tot de eerste hanger mag niet groter  
zijn dan 400mm.*

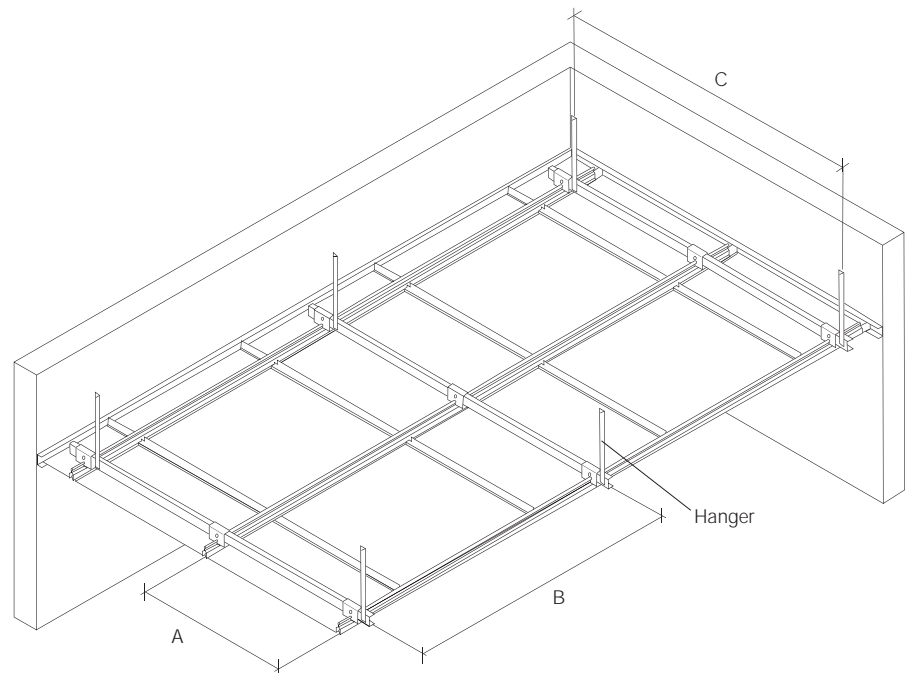
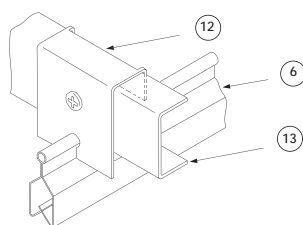







Beschikbaarheid van producten verschilt per land.  
Neem contact op met ons MSC voor specifieke productinformatie.

# ORCAL 3000 SYSTEEM

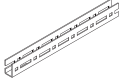
Zichtbaar 100 mm ophangstelsel (nominaal).

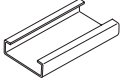

## Voor gebruik met Fastrak producten

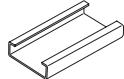
	Item Nr.	Omschrijving	Afmetingen (mm)	Hoeveelheid stuks	Gewicht / Pak kg
	BPM 300100	U-draagprofiel	3750	10	30,00
	BPM 300121	Ophangbeugel voor 6mm draadeind	-	100	2,20
	BPM 300119	U-draagprofiel langsvorbinder	-	100	4,70
	BPM 300140	Universele wandbevestiger	-	100	3,90
	BPM 300120	Borgclip	-	100	0,30
	BPM 215500	C-profiel RAL9010 100mm breedte	4000	4	32,80
	BPM 300118	C-profiel hanger haak	-	100	-
	BPM 300144	C-profiel verbinder muurbevestiging	-	10	0,80
	BPM 311067	Verlengstuk voor C-profielen	-	10	8,00

## Ophangstelsel

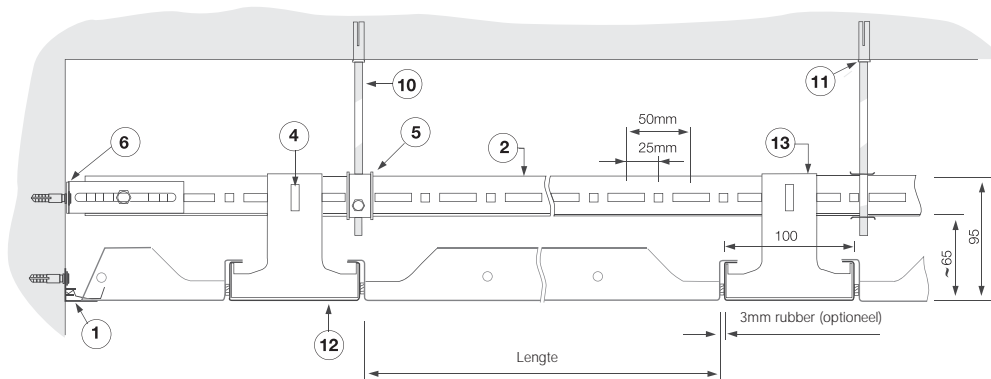

Voor randafwerkingen, hangers en accessoires, zie pagina 46  
Alle afmetingen zijn in mm. Alle maten zijn nominaal.

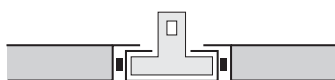

# ORCAL 3000 SYSTEEM

**Detailtekening**

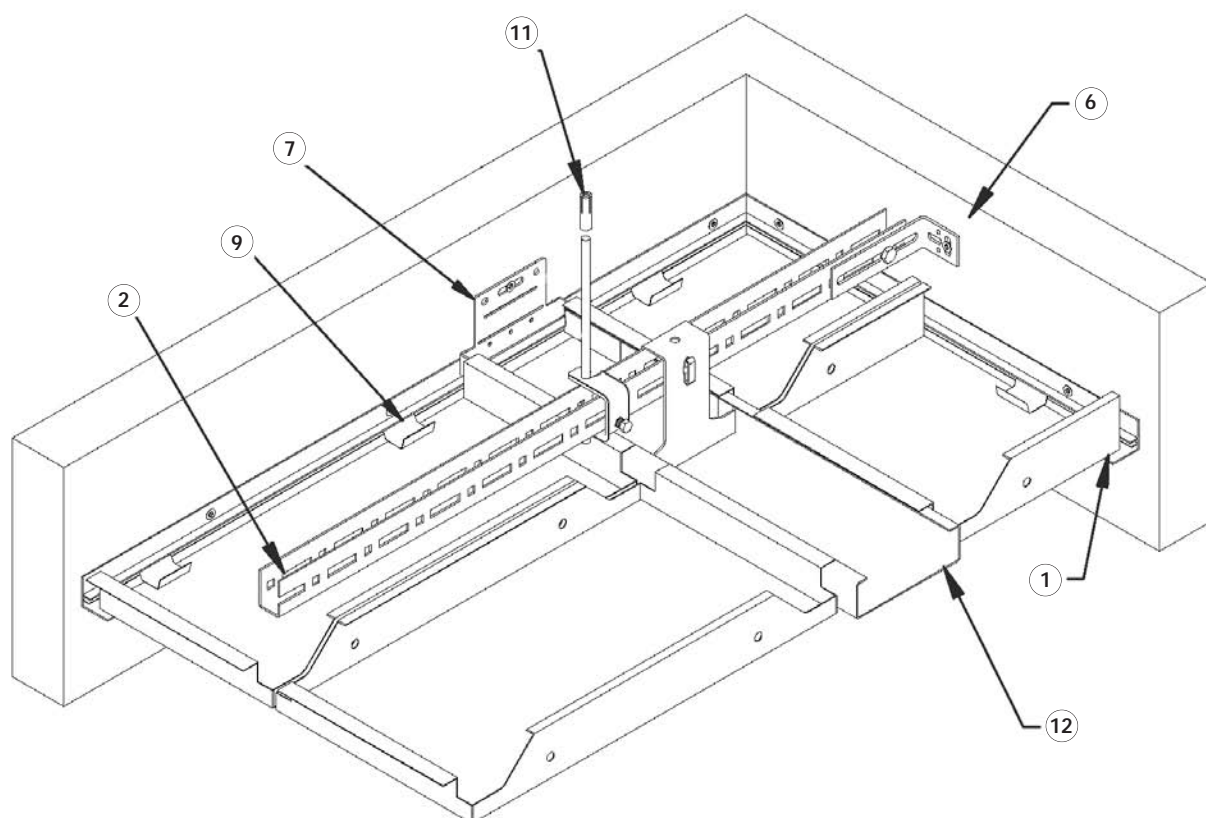

**Fig. Item No.**

1	BPM 215013	F-wandprofiel
2	BPM 300100	U-profiel
3	BPM 300119	U-draagprofiel langsverbinder
4	BPM 300120	Borgclip
5	BPM 300121	Ophangbeugel
6	BPM 300140	Wandbevestiger
7	BPM 300144	C-profiel Wandbevestiger

**Fig. Item No.**

8	BPM 311067	C-profiel verbinder
9	BPM 311081	Klemveer
10	BPA 1829 G	Draadeind
11	BPM 311111	Ophangbeugel met 6 mm draadeind
12	BPM 215500	C-profiel
13	BPM 300118	C-profiel hanger