

BANDRASTER

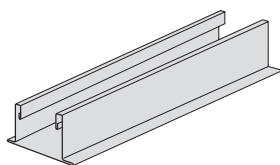

Bandraster is een ophangstelsel met een volledig reeks aan verschillende breedtes, geschikt voor het Prelude 24 TLX/XL² dwarsprofiel.

Bandraster Systeem

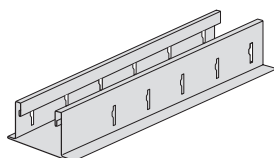
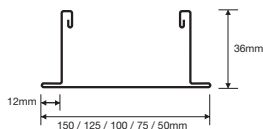

Item Nr.	Afmetingen		Inhoud / Pak		Gewicht / Pak	Pakken / Pallet
	lengte (mm)	hoogte (mm)	stuks	lm		

Gesleufd om de 312,50 mm (1)

BP 36 2100 B	3750	100	8	30,00	32,60	16
--------------	------	-----	---	-------	-------	----

Gesleufd om de 100 mm (1)

BP 36 3050	3600	50	8	28,80	24,00	28
BP 36 3075	3600	75	8	28,80	27,70	20
BP 36 3100 *	3600	100	8	28,80	31,40	16
BP 36 3125	3600	125	8	28,80	38,30	12
BP 36 3150	3600	150	4	14,40	21,20	20

Ongesleufd (2)

BP 36 0050 A	3600	50	8	28,80	24,00	28
BP 36 0075 A*	3600	75	8	28,80	27,70	20
BP 36 0100 A	3600	100	8	28,80	31,40	16
BP 36 0125 A	3600	125	8	28,80	38,30	12
BP 36 0150	3600	150	4	14,40	21,20	20

(1) is compatibel met alle randdetails, zelfs met inbegrip van Orcal planks (SE, TE8, TE16, TE30) en SL2 planks, maar de slots zijn niet nodig voor Orcal en SL2 planks.

(2) is slechts compatibel met Orcal planks (SE, TE8, TE16, TE30) en SL2 planks (d.w.z. geen Tegular of MicroLook Planks).

Bandraster Accessoires

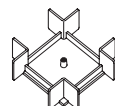
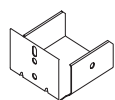
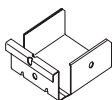
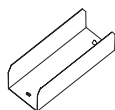
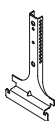
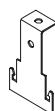

Item Nr.	Omschrijving	Afmeting breedte (mm)	Inhoud / Pak stuks	Gewicht / Pak kg
BPA 36 0501	Ophanger	50	50	1,20
BPA 36 0751		75	50	1,50
BPA 36 1001		100	50	1,80
BPA 36 0502 G	Nonius hanger	50	100	5,80
BPA 36 0752 G		75	100	8,10
BPA 36 1002 G		100	100	11,00
BPA 36 1252 G		125	100	12,50
BPA 36 1502 G		150	100	15,00
BPA 36 0503 G	Koppelstuk	50	100	8,00
BPA 36 0753 G		75	100	8,30
BPA 36 1003 G		100	100	14,00
BPA 36 1253 G		125	100	17,00
BPA 36 1503 G		150	100	19,50
BPA 36 0504 G	90° koppelstuk	50	100	5,80
BPA 36 0754 G		75	100	8,10
BPA 36 1004 G		100	100	11,00
BPA 36 1254 G		125	100	12,50
BPA 36 1504 G		150	50	7,50
BPA 36 0505 G	Wandprofiel eindbevestiging	50	100	5,80
BPA 36 0755 G		75	100	8,10
BPA 36 1005 G		100	100	11,00
BPA 36 1255 G		125	100	12,50
BPA 36 1505 G		150	50	7,50
BPA 36 0506 G	Kruiskoppelstuk	50	48	7,70
BPA 36 0756 G		75	30	5,70
BPA 36 1006 G		100	32	7,40

* Ook verkrijgbaar in RAL 9010 (WR).

Alle afmetingen zijn in mm. Alle maten zijn nominaal.

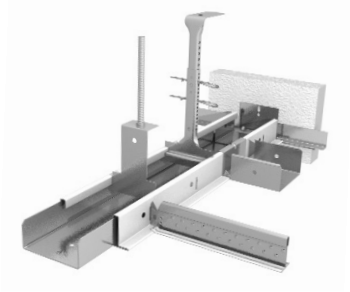

BANDRASTER

Installatie Tekening

- Bandraaster is geschikt voor Prelude 24 XL² of Prelude 24 TLX dwarsprofielen.
- Op speciaal verzoek: Prelude 15 TL kan geschikt gemaakt worden voor installatie met bandraaster.
- Speciale sleufgaten; minimale ruimte tussen de sleuven is 50 mm; maximale lengte van een bandraaster is 6000 mm.

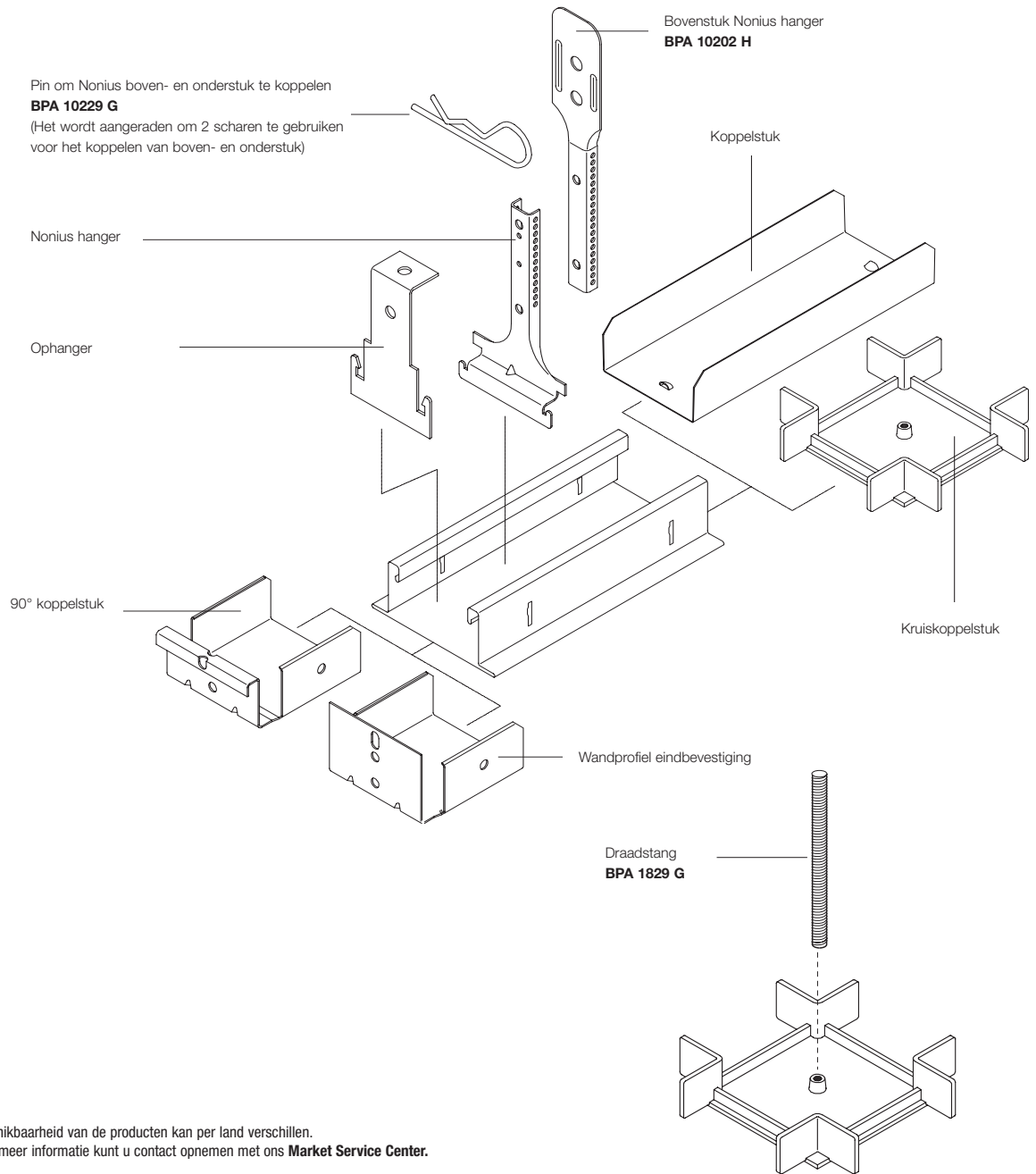

Beschikbaarheid van de producten kan per land verschillen.
Voor meer informatie kunt u contact opnemen met ons **Market Service Center**.

ARMSTRONG BUILDING PRODUCTS B.V.

Verkoopkantoor Nederland

Office Building Quadrium
 Claudius Prinsenlaan 126
 4818 CP Breda
 Tel: (+31) 076 521 77 33 (NL)
 (+32) 02 223 00 72 (BL)
 Fax: (+31) 076 521 04 07
 e-mail : benelux-info@armstrong.com

www.armstrong.nl/plafonds
www.armstrong-plafonds.be
www.armstrong.eu

